

WAAS CH 86843 W10A	APP CRS 102°	Rwy Idg TDZE Apt Elev	3499 128 128
--	------------------------	-----------------------------	---

RNAV (GPS) RWY 10

PRINCETON (39N)

RNP APCH.	<p>▼ Rwy 10 helicopter visibility reduction below 1 SM NA. Baro-VNAV NA.</p> <p>▲ NA Procedure NA at night. Use Trenton altimeter setting.</p>	MISSED APPROACH: Climb to 2700 direct JETOR and hold.
-----------	--	---

TTN ASOS 126.775	NEW YORK APP CON 132.8 379.9	UNICOM 122.725 (CTAF)	123.05 0
----------------------------	--	---------------------------------	-----------------

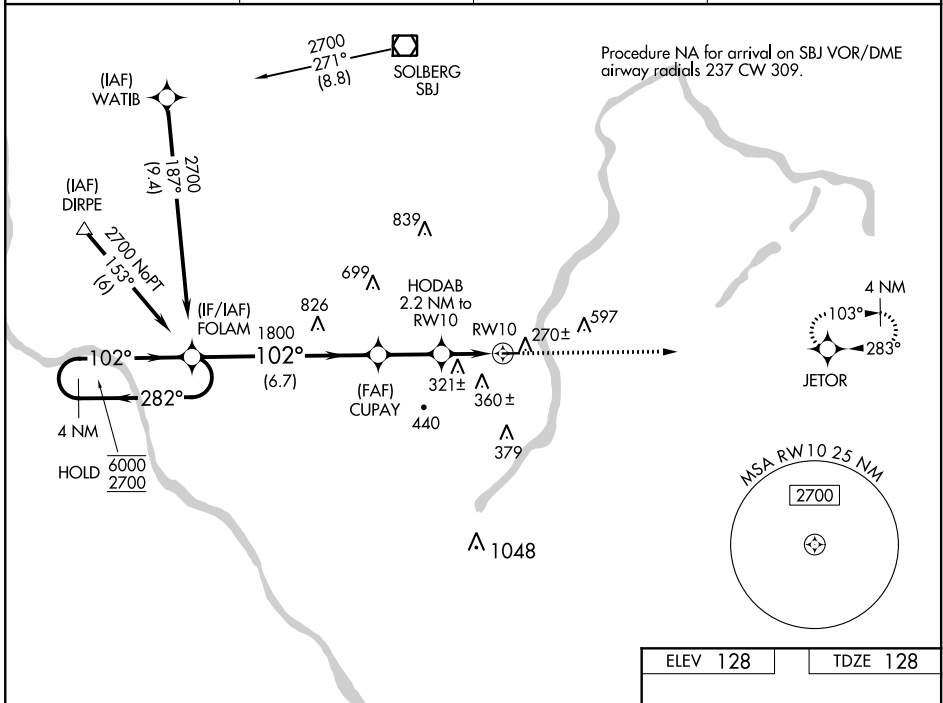

NE-2, 09 SEP 2021 to 07 OCT 2021

NE-2, 09 SEP 2021 to 07 OCT 2021

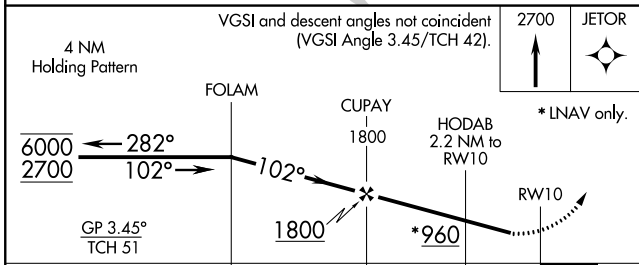

ELEV 128	TDZE 128
----------	----------

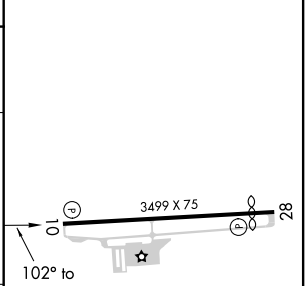

CATEGORY	A	B	C	D
LPV DA		441-1	313 (400-1)	
LNAV/VNAV DA		533-1½	405 (500-1½)	
LNAV MDA	580-1	452 (500-1)	580-1¾	452 (500-1¾)
CIRCLING	760-1 632 (700-1)	840-1 712 (800-1)	940-2½ 812 (900-2½)	1000-2¾ 872 (900-2¾)

MIRL Rwy 10-28 0

REIL Rwy 10 0

RNAV (GPS) RWY 28

PRINCETON (39N)

APP CRS 282°	Rwy Idg TDZE Apt Elev	3130 128 128
------------------------	-----------------------------	---

RNP APCH.	<p>▼ Use Trenton Mercer altimeter setting, if not received use Somerset altimeter setting. Procedure NA at night. Rwy 28 helicopter visibility reduction below 1 SM NA.</p> <p>▲NA</p>	MISSED APPROACH: Climb to 2700 direct FOLAM and hold.
-----------	--	---

TTN ASOS 126.775	NEW YORK APP CON 132.8 379.9	UNICOM 122.725 (CTAF)	123.05 0
----------------------------	--	---------------------------------	------------------------

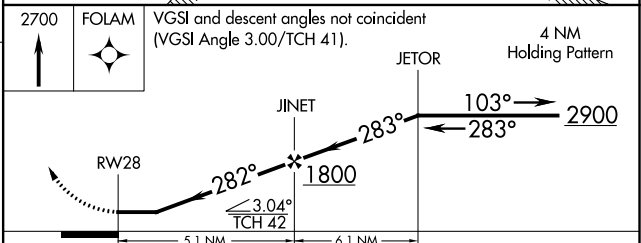
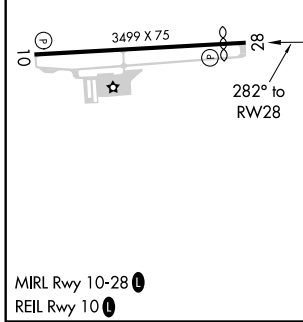
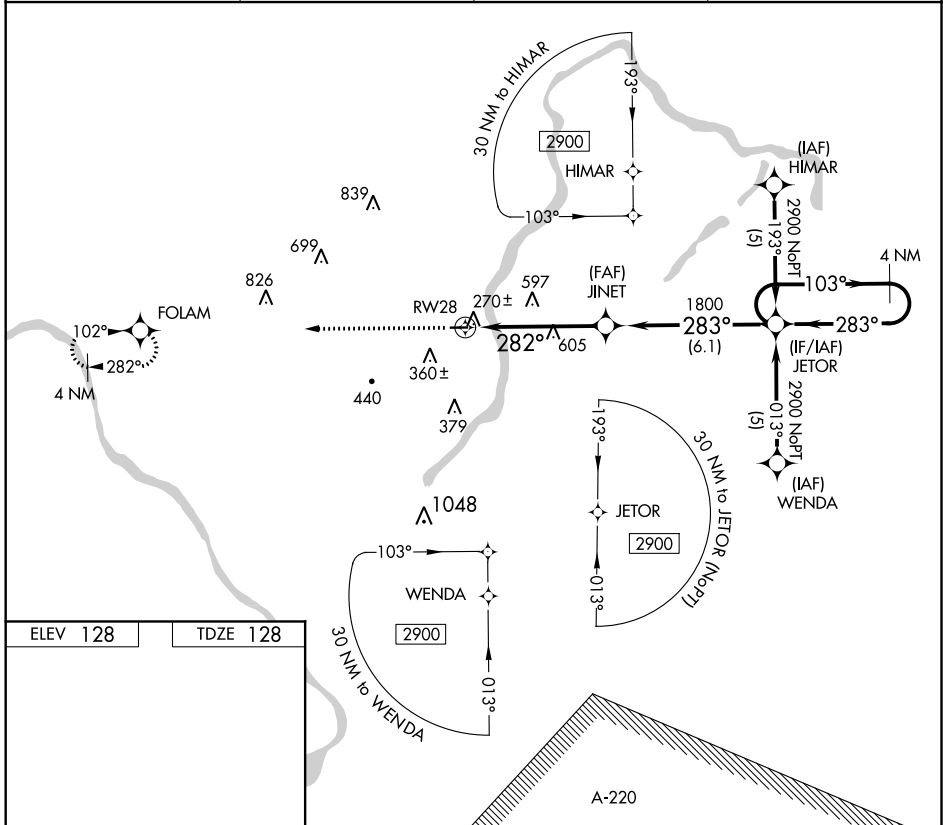

CATEGORY	A	B	C	D
RNAV MDA	900-1 772 (800-1)	900-1¼ 772 (800-1¼)	900-2¼ 772 (800-2¼)	NA

NE-2, 09 SEP 2021 to 07 OCT 2021

NE-2, 09 SEP 2021 to 07 OCT 2021

VOR/DME SBJ 112.9 Chan 76	APP CRS 171°	Rwy Idg TDZE Apt Elev 128	N/A N/A
---	------------------------	--	--------------------------

VOR-A
PRINCETON (39N)

DME required.	MISSED APPROACH: Climbing left turn to 2300 direct SBJ VOR/DME and hold.
---------------	--

TTN ASOS 126.775	NEW YORK APP CON 132.8 379.9	UNICOM 122.725 (CTAF)	123.05 0
----------------------------	--	---------------------------------	------------------------

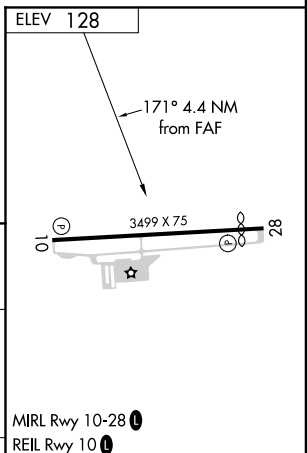
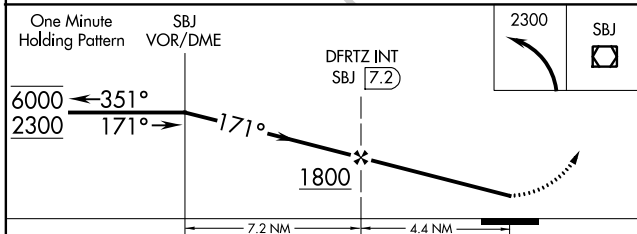
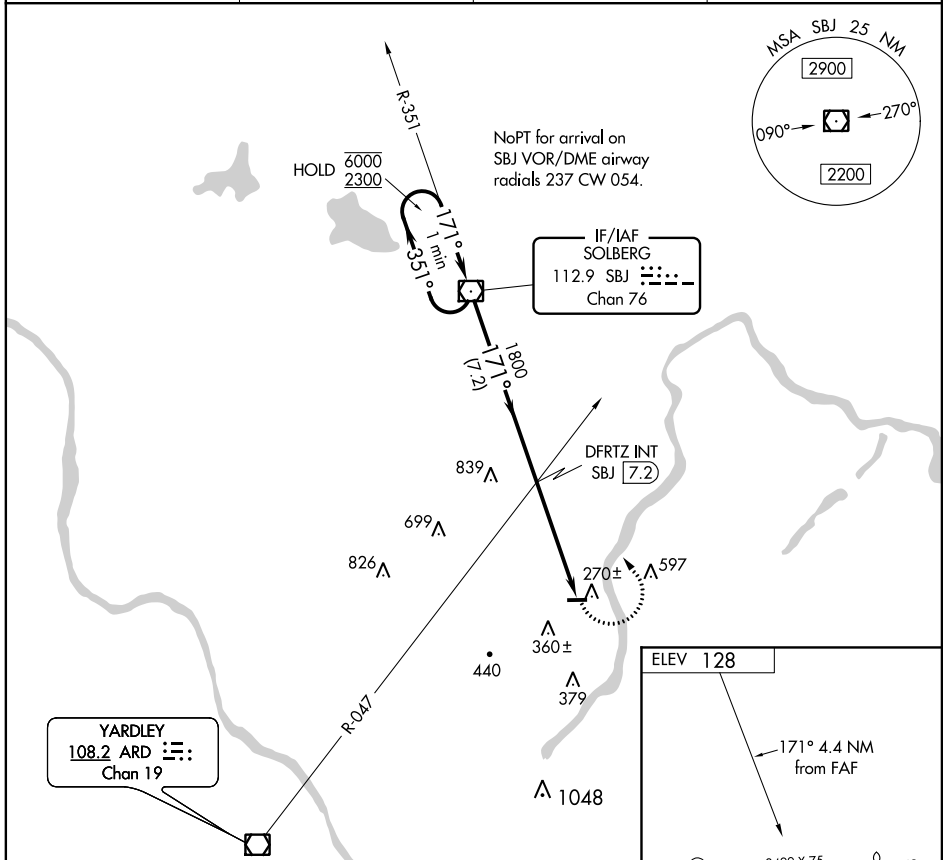

CATEGORY	A	B	C	D
CIRCLING	1040-1¼	912 (1000-1¼)	NA	NA

FAF to MAP 4.4 NM					
Knots	60	90	120	150	180
Min:Sec	4:24	2:56	2:12	1:46	1:28

NE-2, 09 SEP 2021 to 07 OCT 2021

NE-2, 09 SEP 2021 to 07 OCT 2021